

P/N: RE-C-SMA025

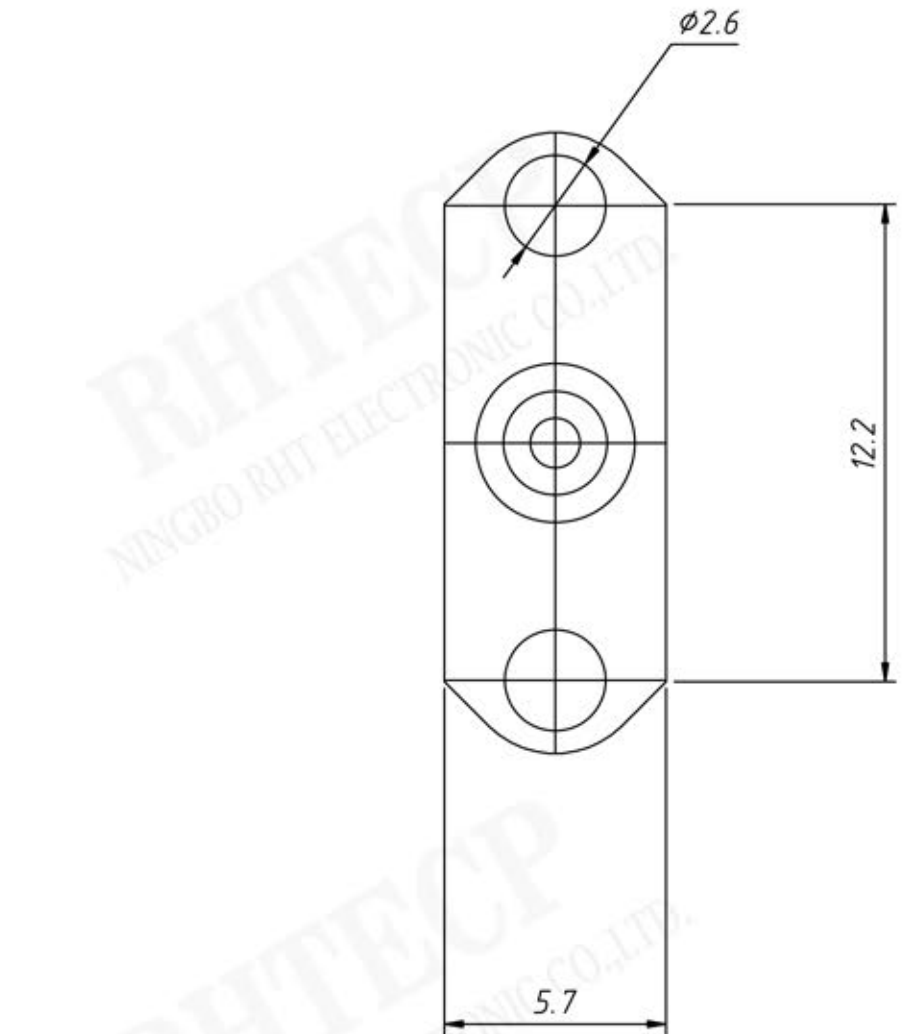
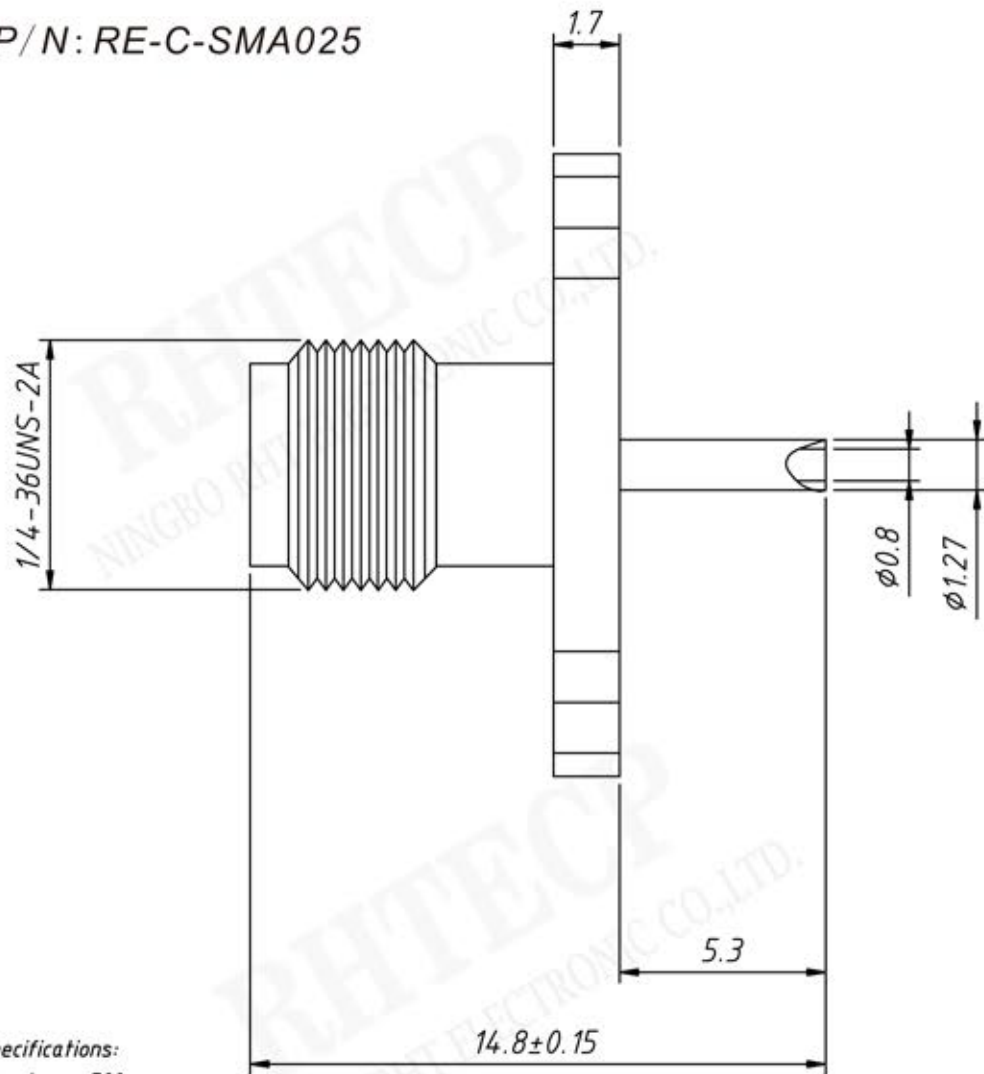

Specifications:
 Impedance: 50 Ω
 Frequency Range: 0-3GHz
 Material: Brass
 Surface: Gold Plating
 Durability: 500Cycles Min